

**Boomer**

**Off-Handle**

pamar

# Off-Handle!

Maniglie per una nuova dimensione  
Handles for a new dimension

The door handle, undisputed queen of living spaces, has always been in Pamar's DNA, even when the factory was known as "Officine Pamar" in the early 1960s.

At that time, production was focused on brass and aluminium die casting, the entire collection was characterized by soft shapes, direct linked to the classic style of that period.

In the following years, Pamar specialized its production in accessories dedicated to the world of furniture.

It was at the beginning of the 90s when architect Pinuccio Borgonovo, already an established figure in the furniture industry, proposed to Pamar a new door handle that goes crossed the dogma of the "house handle" and turns into an elegant accessory, sophisticated with clean lines into a minimalist robe.

Zamak frames moving entire glass doors and walls become the collection symbol.

This handle found its own space in the 2010 "Basic" catalogue and obtained a lead role not only in work places, but also in private ones. In the following years, the collection included new models, capable of answering the necessities of the audience: from the patent hole to the yale hole, from the fixing on glass to the fixing on wood.

Today, the new collection design by P. Borgonovo will be the ward in Pamar new "Off-handle" catalogue: handles will introduce users into a new physical and theoretical dimension. The collection includes two variants: the first one with anti-panic closure, in order to guarantee confidentiality and privacy of spaces; the second in its pure version. Protected both by aesthetic and technical-structural patents, these handles are equipped with magnetic fixing, a feature simplifying the assembly and guaranteeing their duration.

La maniglia per porta, regina indiscussa dell'arredo, è sempre stata nel DNA di Pamar, ancora quando era conosciuta con il nome di "Officine Pamar" agli inizi degli anni '60.

Allora la produzione si concentrava sulla fusione dell'ottone e dell'alluminio con forme e stili classici legati alla cultura dell'epoca. Negli anni successivi Pamar si specializzava nella produzione di accessori dediti al mondo del mobile.

È agli inizi degli anni '90 che l'architetto Pinuccio Borgonovo, già figura affermata nel settore dell'arredo, propone a Pamar una nuova maniglia per porta che supera il dogma della "maniglia di casa" e si trasforma in un accessorio elegante, sofisticato con linee pulite da un design minimalista.

L'emblema della collezione resta il frame di zama che muove porte e pareti in vetro. Questa trova spazio nel catalogo generale "Basic" del 2010, diventando protagonista non solo negli ambienti lavorativi, ma anche in quelli privati.

Negli anni seguenti, la collezione si espande con nuovi modelli, capaci di rispondere alle esigenze del pubblico: dal foro patent a quello yale, dal fissaggio su vetro a quello su legno.

Oggi, la nuova collezione proposta dall'architetto Borgonovo sarà la protagonista del nuovo catalogo Pamar "Off-handle", maniglie che introducono l'utente in una nuova dimensione sia fisica che teorica. Essa comprende due varianti: una con chiusura anti-panico, ideale per garantire la riservatezza e la privacy degli spazi; la seconda nella versione in purezza. Entrambe, protette da brevetto sia estetico che tecnico-strutturale, sono dotate di fissaggio magnetico che ne semplifica il montaggio e ne garantisce la durata.

Creare una maniglia  
è come creare una poesia,  
hanno in comune lo stesso  
*approccio sensibile*  
è curioso: è come  
inventare un universo nuovo.

Create a handle  
is like creating a poem,  
they have in common the same  
*sensitive approach*  
it's curious: it's like  
inventing a new universe.







 MN 2648 Z pag 11	 MN 1098 Z pag 35	 MN 1031 Z pag 55	 MN 2242 Z pag 79
 MN 2647 Z pag 15	 MN 1099 Z pag 37	 MN 2414 Z pag 55	
 MN 2670 Z pag 19 pag 85	 MN 1100 Z pag 39	 MN 1158 Z pag 61	 MN 2132 Z pag 86
 MN 2668 Z pag 21		 MN 2675 Z pag 63	 MN 295 Z pag 87
 MN 2669 Z pag 25	 MN 2583 Z pag 43	 MN 2549 Z pag 71	 MN 2313 Z pag 88
 MN 1097 Z pag 31	 PO 2096 Z pag 47	 MP 756 Z pag 75	 MN 503 Z pag 89
 MN 1096 Z pag 33	 MN 1032 Z pag 51		 MN 469 Z pag 91

# Ad ogni porta la sua maniglia Every door has its own handle

La nostra simbologia per meglio guidarvi nell'identificazione dell'accessorio adatto per completare nonchè impreziosire il progetto della vostra porta.

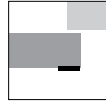
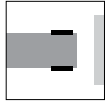
Our guidelines to better support you in the identification of the most suitable accessory to complete as well as enhance your door project.

		
Maniglia per porta scorrevole a incasso totale Handle for sliding total built-in door	Maniglia per porta scorrevole a incasso parziale Handle for sliding partial built-in door	Maniglia per porta battente Handle for push-pull door
		
Maniglia monofaccia Front handle	Maniglia bifacciale Back to back handle	Maniglia di testa a incasso totale Puller



# Sliding and swing doors handles



**MN 2648 Z**  
Design Pinuccio Borgonovo





Collezione "Alice" nella sua versione in purezza. Moderna e discreta nelle sue forme, consente il movimento scorrevole di porte e ante completamente a scomparsa.

"Alice" collection in its pure version. Its modern and discrete shapes allow the sliding movement of completely hidden doors and panels.

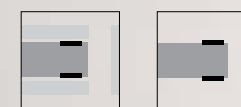
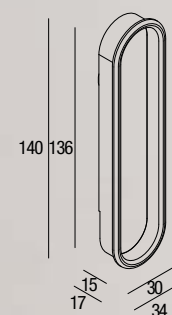

Porta spessore minimo 35 mm  
Montaggio legno, metallo

Door minimum thickness 35 mm  
Assembly on wood and metal doors

Protetta da brevetto sia estetico che tecnico strutturale, tra le sue caratteristiche più innovative presenta il fissaggio magnetico della piastra che ne consente anche uno smontaggio successivo. Disponibile in molteplici finiture ed effetti laccati in tonalità pastello o metallizzati, realizzati con vernici multistrato di ultima generazione nel rispetto più totale delle politiche ambientali. Maniglia realizzata in pressofusione di "zama".

"Alice" is protected by technical as well as aesthetic patent. Among its most innovative features stands out the magnetic fixing of the plate, which consents also a future disassembling. The collection is available in different finishes and pastel or metallized lacquered effects, all realized with the latest generation multilayer paints in the total respect of European environmental politics. Article is die-casted "zamack".





**MN 2647 Z**  
Design Pinuccio Borgonovo





Collezione "Alice" con chiusura antipanico. Ideale per garantire riservatezza e privacy degli spazi per meglio custodire i vs segreti.

"Alice" collection with anti-panic closure, the best solution to grant discretion and space privacy to better guard your secrets.

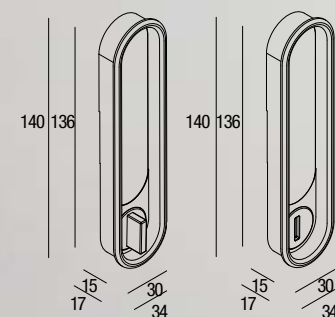

Porta spessore minimo 40 mm  
Montaggio legno, metallo

Door minimum thickness 40 mm  
Assembly on wood and metal doors

Anch'essa protetta da brevetto sia estetico che tecnico strutturale, tra le sue caratteristiche più innovative presenta il fissaggio magnetico della piastra che ne consente anche uno smontaggio successivo.

Disponibile in molteplici finiture ed effetti laccati in tonalità pastello o metallizzati, realizzati con vernici multistrato di ultima generazione nel rispetto più totale delle politiche ambientali. Maniglia realizzata in pressofusione di "zama".

Also this version is protected by technical as well as aesthetic patent.

Among its most innovative features stands out the magnetic fixing of the plate, which consents also a future disassembling.

The collection is available in different finishes and pastel or metallized lacquered effects, all realized with the latest generation multilayer paints in the total respect of European environmental politics. Article is die-casted "zamack".



A completamento della collezione Alice, il puller dedicato.  
Stesso sistema di montaggio brevettato con magneti e shapes.

To complete "Alice" collection, here is its own puller.  
It is identified by the same mounting and aesthetic patents with magnets and shapes.

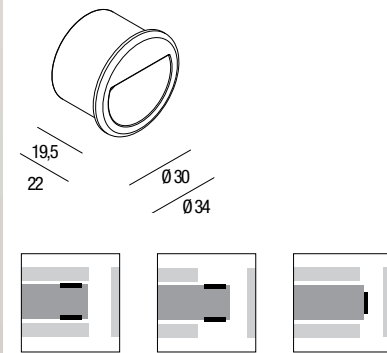

Montaggio legno, metallo

Assembly on wood and metal doors



MN 2670 Z  
Design Pinuccio Borgonovo





**MN 2668 Z**  
Design Pinuccio Borgonovo



Collezione "Alice" nella sua variante a ponte. Composta da due cilindri in zama pressofusa che mordono una trafilata in alluminio, riprendendo le "shapes" emblematiche della raccolta.

"Alice" in its bridge version. It's composed by two die-casted "zamack" cylinders which bite an aluminium profile taking up the emblematic "shapes" of the collection.



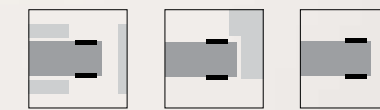
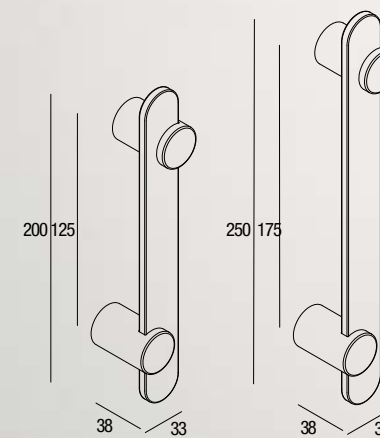

Porta spessore minimo 6 mm  
 Montaggio legno, metallo, vetro  
 Foratura non in asse

Door minimum thickness 6 mm  
 Assembly on wood, metal and glass doors  
 Off-axis drilling

Disponibile in molteplici combinazioni cromatiche, tra effetti galvanici e finiture laccate, realizzate con vernici multistrato di ultima generazione. La maniglia presenta un fissaggio bifrontale che ne consente l'utilizzo su porte scorrevoli e battenti. L'utilizzo di un estruso di alluminio come impugnatura dona alla maniglia robustezza, nonché la possibilità di realizzare misure su richiesta.

This model is available in many different chromatic combinations, between galvanic and lacquered effects, all realized with the latest generation multilayer paints. The handle has a back to back fixing, which permits you to use it on sliding as well as push-pull doors. The use of an aluminium profile as handgrip gives strength as well as the possibility to make sizes on request.



**MN 2669 Z**  
Design Pinuccio Borgonovo





Il dettaglio distintivo di questa versione è sicuramente il particolare innesto tra l'estruso di alluminio racchiuso dalle basi cilindriche in zama pressofusa. Restano molteplici le combinazioni tecnico-estetiche cromatiche.

The singular detail of this version is surely the special connection between the extruded aluminium and the two cylindrical bases in die-casted "zamak". The technical and aesthetic chromatic combinations remain multiple.

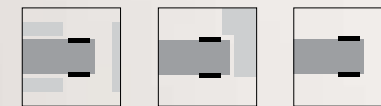
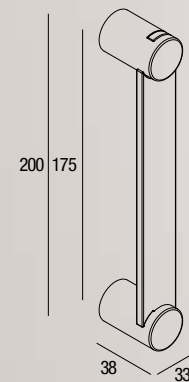

Porta spessore minimo 6 mm  
Montaggio legno, metallo, vetro

Door minimum thickness 6 mm  
Assembly on wood, metal and glass doors

Libero  
pensiero

Free  
Thinking







Linee rette e temperanti caratterizzano la collezione "Manhattan", qui nella sua versione pura.  
 Movimento scorrevole, completamente a scomparsa.  
 Interessante il fissaggio della piastra sulla maniglia, grazie a delle clip in nylon che ne consentono il rapido montaggio.  
 Realizzata in pressofusione di "zama".  
 Disponibile in finiture laccate sia nei colori pastello che metallizzati, vernici multistrato di ultima generazione nel rispetto più totale delle politiche ambientali.

Straight and tempering lines characterize "Manhattan" collection, here in its pure version.  
 Sliding movement, completely hidden.  
 The fixing of the plate on the handle is interesting, thanks to the nylon clips that allow the quick assembly.  
 Made in die-casted "zamak".  
 Available in different finishes and pastel or metallized lacquered effects, all realized with the latest generation multilayer paints in the total respect of European environmental politics.

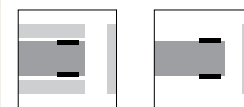
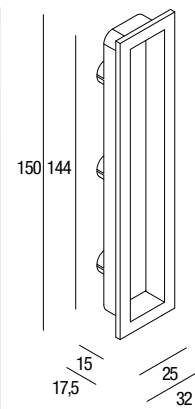

Porta spessore minimo 35 mm  
 Montaggio legno, metallo

Door minimum thickness 35 mm  
 Assembly on wood and metal doors



**MN 1097 Z**  
 Design Pinuccio Borgonovo





Collezione Manhattan con chiusura antipánico.  
 In questo caso movimento scorrevole con incasso parziale.

"Manhattan" collection with anti-panic closure.  
 In this case the handle allows the partial sliding hidden movement.

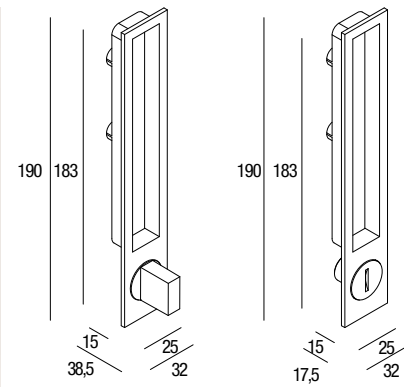

Porta spessore minimo 40 mm  
 Montaggio legno, metallo

Door minimum thickness 40 mm  
 Assembly on wood and metal doors



**MN 1096 Z**  
 Design Pinuccio Borgonovo



# MN 1098 Z

Design Pinuccio Borgonovo

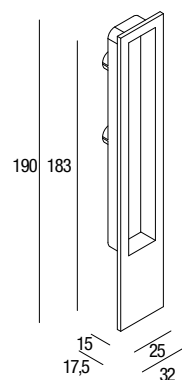

Collezione Manhattan.  
Movimento scorrevole,  
completamente a scomparsa.

"Manhattan" collection.  
Sliding movement, completely hidden.



Porta spessore minimo 40 mm  
Montaggio legno, metallo

Door minimum thickness 40 mm  
Assembly on wood and metal doors



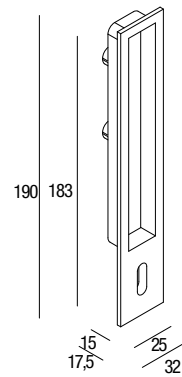

Collezione Manhattan con foro Patent  
 "Manhattan" collection with Patent keyhole

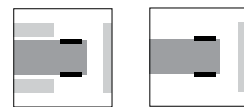

Porta spessore minimo 40 mm  
 Montaggio legno, metallo  
 Door minimum thickness 40 mm  
 Assembly on wood and metal doors



MN 1099 Z  
 Design Pinuccio Borgonovo



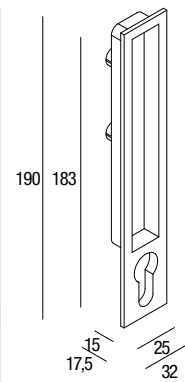

Collezione Manhattan con foro Yale  
 "Manhattan" collection with Yale keyhole

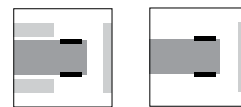

Porta spessore minimo 40 mm  
 Montaggio legno, metallo  
 Door minimum thickness 40 mm  
 Assembly on wood and metal doors



MN 1100 Z  
 Design Pinuccio Borgonovo



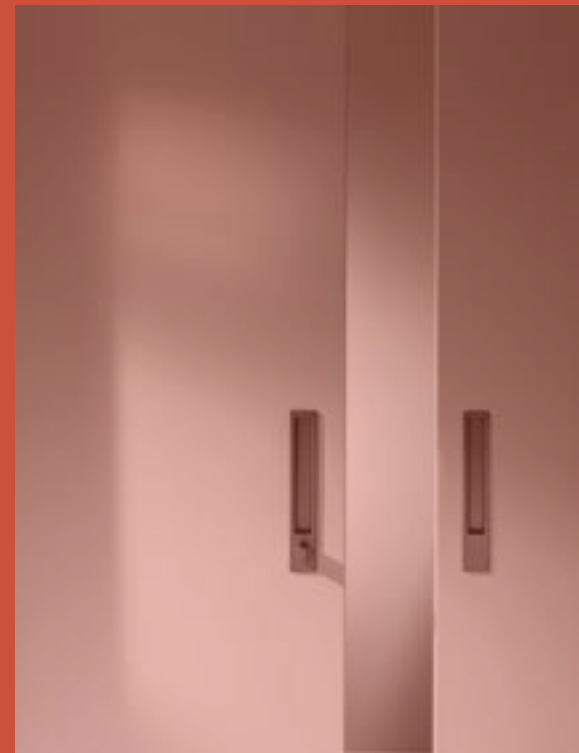

Semplicità

Simplicity



MN 2583 Z  
Design Gioipaw



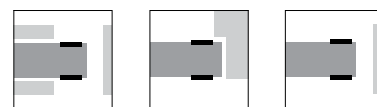
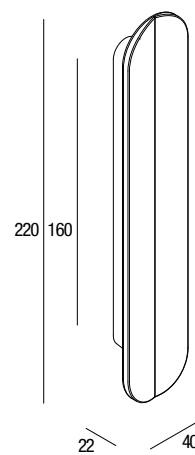

Montaggio legno, metallo

Assembly on wood and metal doors

Collezione "Lotus"  
 Tratti preziosi che disegnano un elemento singolare. Perfetto per essere montato su ante scorrevoli nella sua versione back to back sia in legno che metallo. Disponibile in molteplici finiture ed effetti laccati in tonalità pastello o metallizzati, realizzati con vernici multistrato di ultima generazione nel rispetto più totale delle politiche ambientali. Maniglia realizzata in pressofusione di "zama".

"Lotus" collection  
 Precious traits form a unique element. Its back to back version is perfect for wood or metal sliding panels. Available in different finishes and pastel or metallized lacquered effects, all realized with the latest generation multilayer paints in the total respect of European environmental politics. Made in die-casted "zamak".





PO 2096 Z  
Design Gioipaw



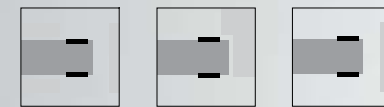
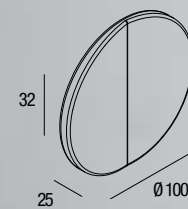

Montaggio legno, metallo  
Assembly on wood and metal doors

A testimonianza del perfetto storico connubio tra maniglia e pomolo, presentiamo quello dedicato alla collezione "Lotus".  
 Perfetto per vestire e impreziosire porte scorrevoli sia in legno che metallo, grazie al discreto montaggio back to back.  
 Disponibile in molteplici finiture galvaniche ed effetti laccati in tonalità pastello o metallizzati, realizzati con vernici multistrato di ultima generazione nel rispetto più totale delle politiche ambientali.  
 Articolo realizzato in pressofusione di "zama".

To proof the perfect historical combination between handles and knobs, we present the one dedicated to "Lotus" collection.  
 Thanks to its discreet back to back installation, it is perfect to dress up and enhance wood and metal sliding doors.  
 Available in different finishes galvanic and pastel or metallized lacquered effects, all realized with the latest generation multilayer paints, in total respect of European environmental politics.  
 Made in die-casted "zamack".



MN 1032 2Z  
Design Pinuccio Borgonovo



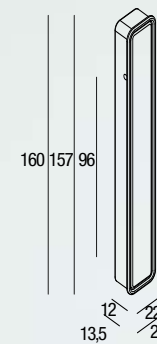

Montaggio legno, metallo

Assembly on wood and metal doors

Arricchisce la collezione Manhattan il modello ad incasso con movimento frizionato e silenzioso. Disponibile in molteplici finiture ed effetti laccati in tonalità pastello o metallizzati, realizzati con vernici multistrato di ultima generazione nel rispetto più totale delle politiche ambientali. Maniglia realizzata in pressofusione di "zama".

The built-in model with soft and silent movement enriches "Manhattan" collection. Available in different finishes and pastel or metallized lacquered effects, all realized with the latest generation multilayer paints in the total respect of European environmental politics. Made in die-casted "zamak".



MN 1031 Z   
MN 2414 Z   
Design Jo Coenen 





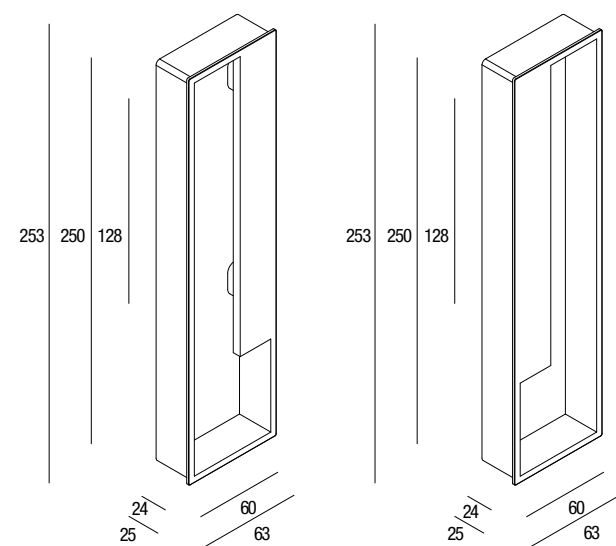

**MN 1031 Z**  
maniglia destra  
right handle

**MN 2414 Z**  
maniglia sinistra  
left handle



Montaggio legno, metallo

Assembly on wood and metal doors

Modello ad incasso ideale per movimento  
complanare delle ante.  
Progettato dall'architetto Coenen, distingue  
l'ambiente con eleganza moderna.  
La piastra può essere rivestita in pelle pieno fiore o  
liscia, in contrasto con la finitura del guscio esterno.  
Disponibile in molteplici finiture ed effetti laccati in  
tonalità pastello o metallizzati, realizzati con vernici  
multistrato di ultima generazione nel rispetto più  
totale delle politiche ambientali.  
Maniglia realizzata in pressofusione di "zama".

This model is perfect for coplanar doors movement.  
Designed by the architect Coenen, this accessory  
distinguishes spaces with modern elegance.  
The plate can be covered in full grain or smooth  
leather, in contrast with the coat of the handle.  
Available in different finishes and pastel or metallized  
lacquered effects, all realized with the latest  
generation multilayer paints in the total respect of  
European environmental politics.  
Made in die-casted "zamak".





A completamento della collezione Manhattan, il modello destinato al mondo porte vetro.  
 Una resistente guarnizione siliconica ne garantisce il fissaggio.  
 Disponibile in molteplici finiture ed effetti laccati in tonalità pastello o metallizzati, realizzati con vernici multistrato di ultima generazione nel rispetto più totale delle politiche ambientali.  
 Maniglia realizzata in pressofusione di "zama".

This version for glass doors completes "Manhattan" collection.  
 A resistant silicon gasket grants the fixing.  
 Available in different finishes and pastel or metallized lacquered effects, all realized with the latest generation multilayer paints in the total respect of European environmental politics.  
 Made in die-casted "zamak"

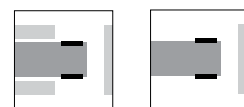
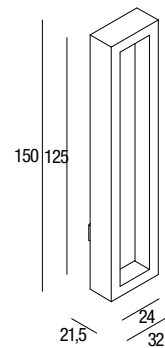

Porta spessore vetro 6/8/10 mm  
 Montaggio su porta in vetro

Door glass thickness 6/8/10 mm  
 Assembly on glass doors

# MN 1158 Z

Design Pinuccio Borgonovo







# MN 2675 Z

Design Pinuccio Borgonovo





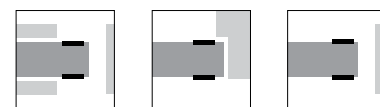
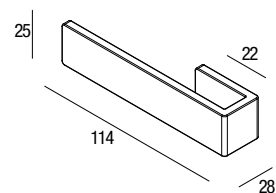

Porta spessore minimo 6 mm  
Montaggio legno, metallo, vetro

Door minimum thickness 6 mm  
Assembly on wood, metal, glass doors

Il modello Zukunft sfiora e simula il classico concetto di maniglia per porta, trasportandolo in un'altra dimensione.

Un prodotto senza tempo destinato al mondo della porta in legno o vetro, grazie alle apposite guarnizioni siliconiche.

Disponibile in molteplici finiture ed effetti laccati in tonalità pastello o metallizzati, realizzati con vernici multistrato di ultima generazione nel rispetto più totale delle politiche ambientali.

Maniglia realizzata in pressofusione di "zama".

"Zukunft" model skims and simulates the classic door handle concept, transporting it to another dimension. A timeless product destined to the world of wood or glass doors, thanks to the special silicone gaskets. Available in different finishes and pastel or metallized lacquered effects, all realized with the latest generation multilayer paints in the total respect of European environmental politics.

Made in die-casted "zamak".



Dettagli e  
Unicità

Details and  
Unicity





**MN 2549 Z**  
Design Centro Ricerche Pamar



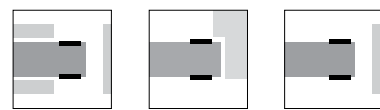
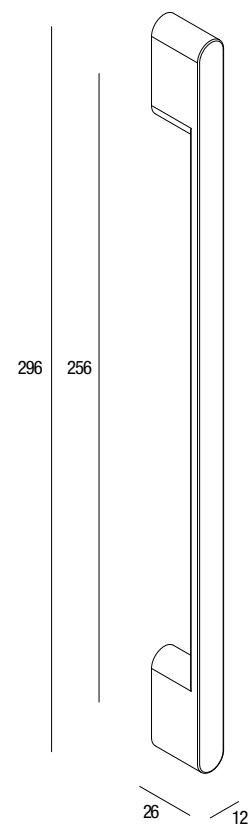

Porta spessore minimo 20 mm  
Montaggio legno, metallo

Door minimum thickness 20 mm  
Assembly on wood and metal doors

Modello Pippermint ideale per il mondo ufficio per vestire porte scorrevoli o battente in legno o metallo, grazie alle apposite guarnizioni siliconiche. Disponibile in molteplici finiture ed effetti laccati in tonalità pastello o metallizzati, realizzati con vernici multistrato di ultima generazione nel rispetto più totale delle politiche ambientali. Maniglia realizzata in pressofusione di "zama".

"Pippermint" model is ideal for office world to dress sliding or push and pull doors in wood or metal, thanks to the special silicone gaskets. Available in different finishes and pastel or metallized lacquered effects, all realized with the latest generation multilayer paints in the total respect of European environmental politics. Made in die-casted "zamak".





# MP 756 Z

Design Marco Redaelli



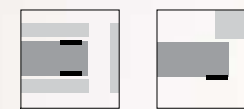
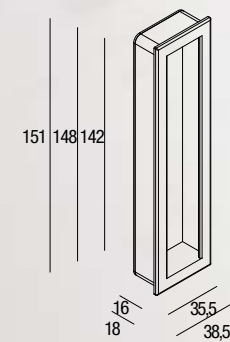

Montaggio legno, metallo

Assembly on wood and metal doors



Modello ad incasso completo per lo scorrevole, non adatto al montaggio back to back.

Disponibile in molteplici finiture ed effetti laccati in tonalità pastello o metallizzati, realizzati con vernici multistrato di ultima generazione nel rispetto più totale delle politiche ambientali.

Maniglia realizzata in pressofusione di "zama".

This model is totally built-in, ideal for sliding doors. It is not suitable for back to back assembly. Available in different finishes and pastel or metallized lacquered effects, all realized with the latest generation multilayer paints in the total respect of European environmental politics. Made in die-casted "zamak".



# MN 2242 Z

Design Centro Ricerche Pamar



Modello storico dell'azienda ad incasso totale nella sua versione frizionata.

This Pamar iconic model is totally buited-in with its soft closure movement.

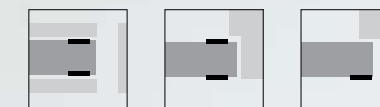
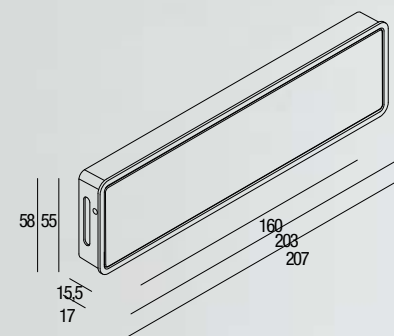

Montaggio legno, metallo

Assembly on wood and metal doors



Disponibile in molteplici finiture galvaniche ed effetti laccati in tonalità pastello o metallizzati, realizzati con vernici multistrato di ultima generazione nel rispetto più totale delle politiche ambientali. Nella sua versione luxury il coperchio accoglie un foglio di vera pelle così da riprendere le nuance dell'armadio.

This model is available in many different chromatic combinations, between galvanic and lacquered effects, all realized with the latest generation multilayer paints in the total respect of European environmental politics. In its luxury version, the top holds a real leather leaf to catch the wardrobe nuances.



# Sliding doors pullers

A completamento della collezione Alice, il puller dedicato. Stesso sistema di montaggio brevettato con magneti e shapes.  
 Disponibile in molteplici finiture ed effetti laccati in tonalità pastello o metallizzati, realizzati con vernici multistrato di ultima generazione nel rispetto più totale delle politiche ambientali.  
 Maniglia realizzata in pressofusione di "zama".

To complete "Alice" collection, here is its own puller. It is identified by the same mounting and aesthetic patents with magnets and shapes.  
 Available in different finishes and pastel or metallized lacquered effects, all realized with the latest generation multilayer paints in the total respect of European environmental politics.  
 Made in die-casted "zamak".

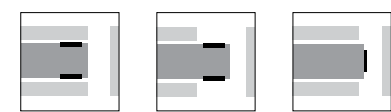

Montaggio legno, metallo

Assembly on wood and metal doors

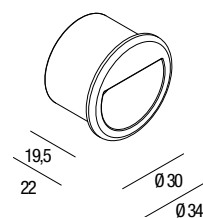

MN 2670 Z  
 Design Pinuccio Borgonovo





**MN 2132 Z**  
 Design Centro Ricerche Pamar

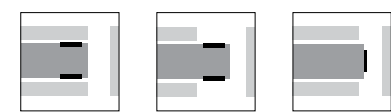

**MN 295 Z**  
 Design Fabio Redaelli
 

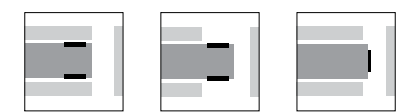
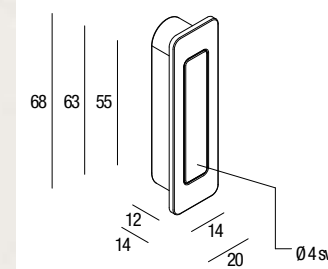
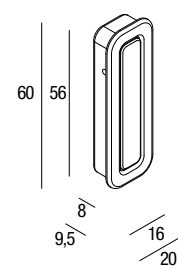

Montaggio legno, metallo  
 Assembly on wood and metal doors



Montaggio legno, metallo  
 Assembly on wood and metal doors



# MN 2313 Z

Design Pinuccio Borgonovo



Una delle ultime entry nella famiglia dei pullers, un modello ricco e discreto: tre diverse possibilità di fissaggio e una sottile guarnizione in gomma per favorire l'impugnatura e il movimento della leva in zama.

One of the latest entries in the pullers family is a rich and discreet model: three different fixing possibilities and a thin rubber gasket to facilitate the handle and the movement of the zamak hilt.

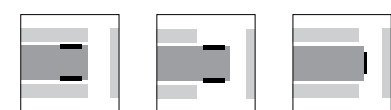

Montaggio legno, metallo

Assembly on wood and metal doors

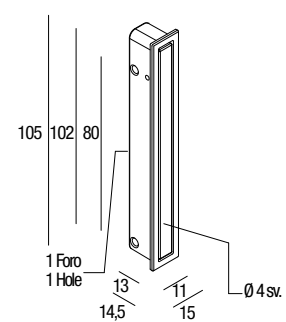

# MN 503 Z

Design Centro Ricerche Pamar

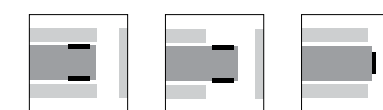
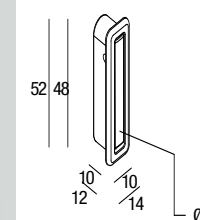

Montaggio legno, metallo

Assembly on wood and metal doors



**MN 469 Z**  
Design Centro Ricerche Pamar

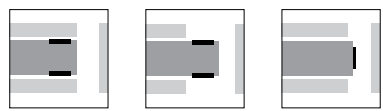

Montaggio legno, metallo  
Assembly on wood and metal doors

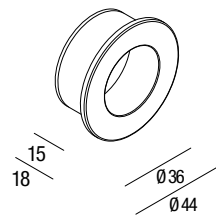



# Finishes





E215

E432

E230



E466

E373

E469

G140



E216

B114

W0798



E438

E507

E390

E437



E226

E228

E229



G139

G251

G220



EZ002

G104

E512

E530



W0349

G102



E237

E463

B119

E343



G245

**PRIVACY** I modelli Pamar sono protetti da brevetto internazionale.  
La contraffazione sarà perseguita a termini di legge.

**AVVERTENZA** Pamar Srl si riserva la facoltà di modificare le caratteristiche tecniche degli elementi illustrati nel presente catalogo in qualunque momento che si ritiene necessario. Descrizioni, foto, colori e misure indicate per i prodotti presenti in catalogo sono solamente indicativi.

**PRIVACY** International patents have been deposited for the Pamar models.  
Imitations will be punished by law.

**ATTENTION** Pamar Srl reserves the right to change technical specifications of products illustrated in this catalogue at any time it deems necessary.  
Descriptions, photos, finishes and product sizes showed in the catalogue are not binding.

Project, Graphic concept  
Fiorella Radice

Photo  
Vincenzo Caccia Fotografie

Copy, translations and supervisor  
Elena Redaelli

Printed in Italy  
Grafica Gioia  
Edizione \_ aprile 2023

# pamar

**Pamar S.r.l.**  
Via Sirtori, 41 20838 Renate (MB) - Italy  
t +39 0362 924661/2/3 f +39 0362 924612  
[pamar@pamar.it](mailto:pamar@pamar.it) [www.pamar.it](http://www.pamar.it)